

WMTJ 20.03.2022 Suchy Las M U18 -50 kg

Competitors

Competitors: 3

#	Name	Grade	Club	1	2	3	Wins	Pts	Pos
1	Marcin LEŚNIEWSKI	2.kyu	LKSSzubinianka		7		1	7	2
2	Szymon KADAJ	2.kyu	Towarzystwo Sportowe GWARDIA Olsztyn				0		3
3	Mansur VAKHAEV	?	Judoschule Kano Bremerhaven				2	20	1

Matches

Match	White			Blue	Result	Time
1	Marcin LEŚNIEWSKI	1	2	Szymon KADAJ	01-00s1	9:53
2	Marcin LEŚNIEWSKI	1	3	Mansur VAKHAEV	00s2-10	2:56
3	Szymon KADAJ	2	3	Mansur VAKHAEV	00-10	0:20

Results

Pos	Name
1	Mansur VAKHAEV, Judoschule Kano Bremerhaven Ge
2	Marcin LEŚNIEWSKI, LKSSzubinianka
3	Szymon KADAJ, Towarzystwo Sportowe GWARDIA Olsztyn

WMTJ 20.03.2022 Suchy Las M U18 -55 kg

Competitors

Competitors: 2

#	Name	Grade	Club	1	2	1	2	1	2	Wins	Pts	Pos
1	Szymon ROSZKOWSKI	2.kyu	UKS Narew Łapy		10		10			2	20	1
2	Mohammed SAIDOV	?	Judoschule Kano Bremerhaven Ge							0	0	2

Matches

Match	White			Blue	Result	Time
1	Szymon ROSZKOWSKI	1	2	Mohammed SAIDOV	10-00	1:43
2	Szymon ROSZKOWSKI	1	2	Mohammed SAIDOV	10-00	0:21
3	Szymon ROSZKOWSKI	1	2	Mohammed SAIDOV		

Results

Pos	Name
1	Szymon ROSZKOWSKI, UKS Narew Łapy
2	Mohammed SAIDOV, Judoschule Kano Bremerhaven Ge

WMTJ 20.03.2022 Suchy Las M U18 -60 kg

Competitors: 11

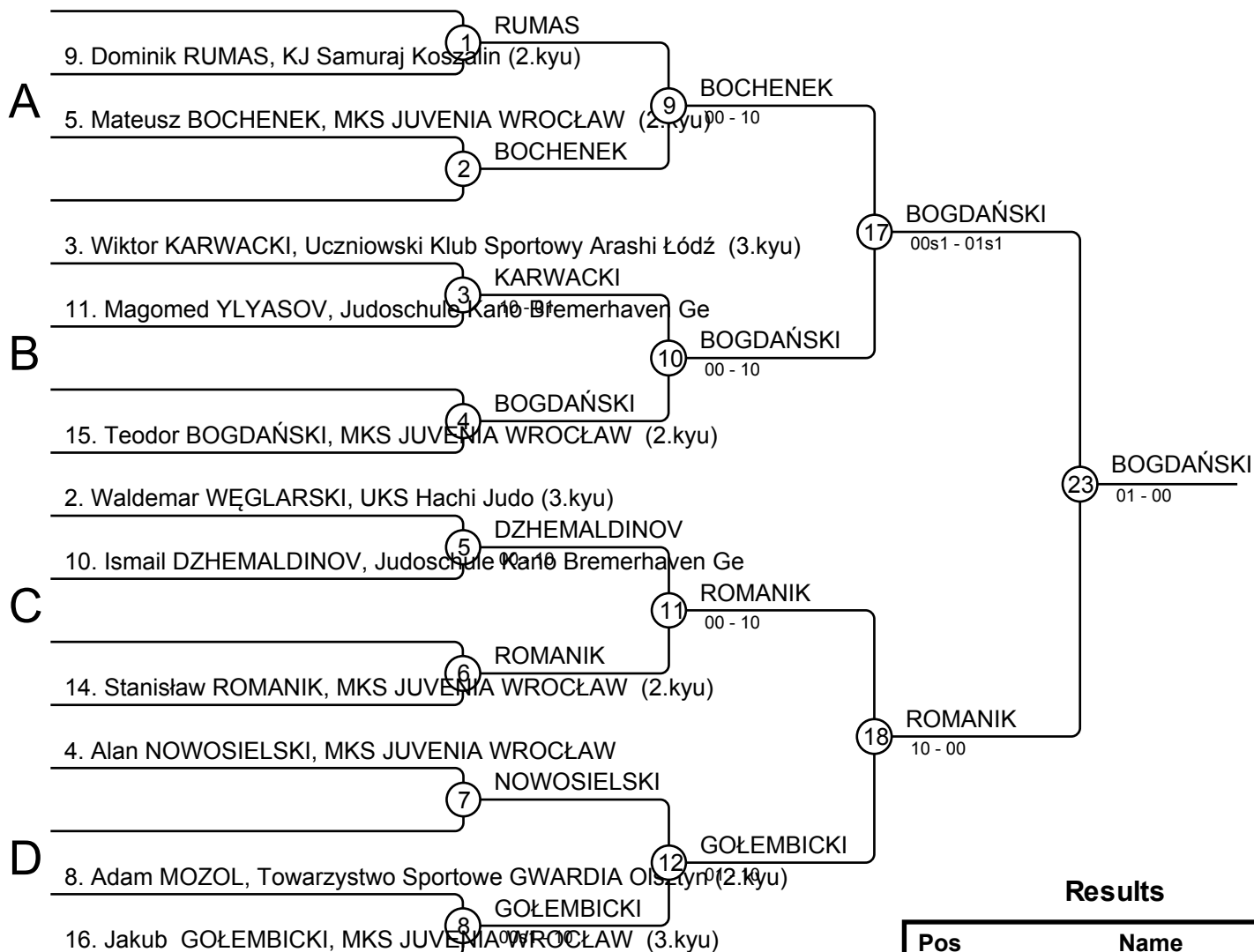

Results

Pos	Name
1	Teodor BOGDAŃSKI, MKS JUVENIA WROCLAW
2	Stanisław ROMANIK, MKS JUVENIA WROCLAW
3	Dominik RUMAS, KJ Samuraj Koszalin
3	Mateusz BOCHENEK, MKS JUVENIA WROCLAW
5	Jakub GOŁEMBICKI, MKS JUVENIA WROCLAW
5	Adam MOZOL, Towarzystwo Sportowe GWARDIA Olsztyn
7	Wiktor KARWACKI, Uczniowski Klub Sportowy Arashi Łódź
7	Ismail DZHEMALDINOV, Judoschule Karlo Bremerhaven Ge

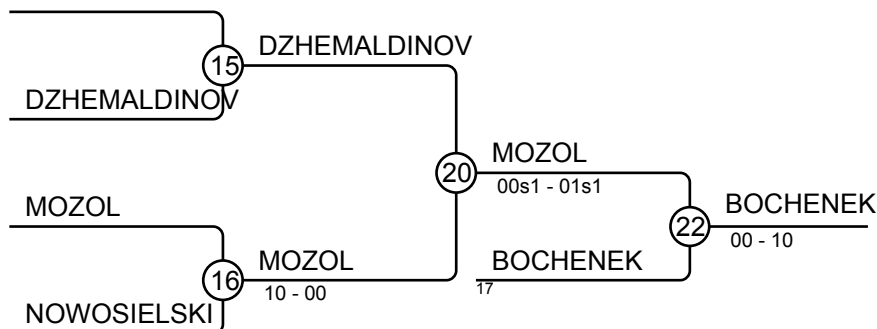
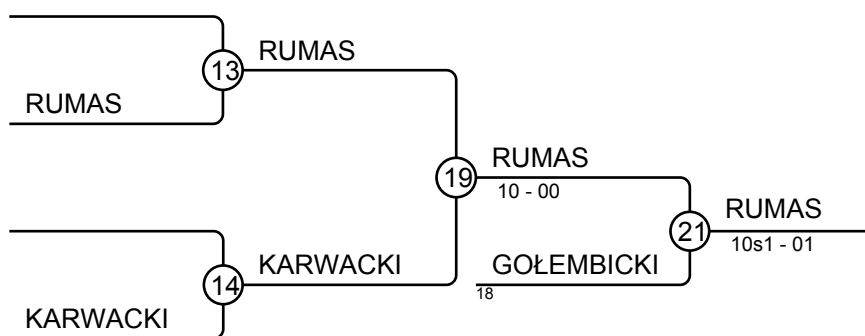

WMTJ 20.03.2022 Suchy Las M U18 -66 kg

Competitors: 23

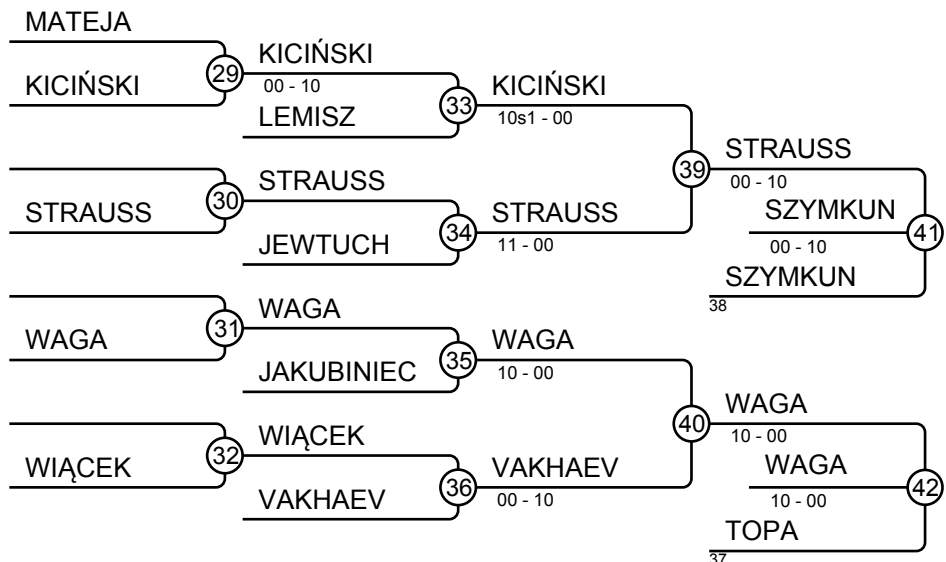
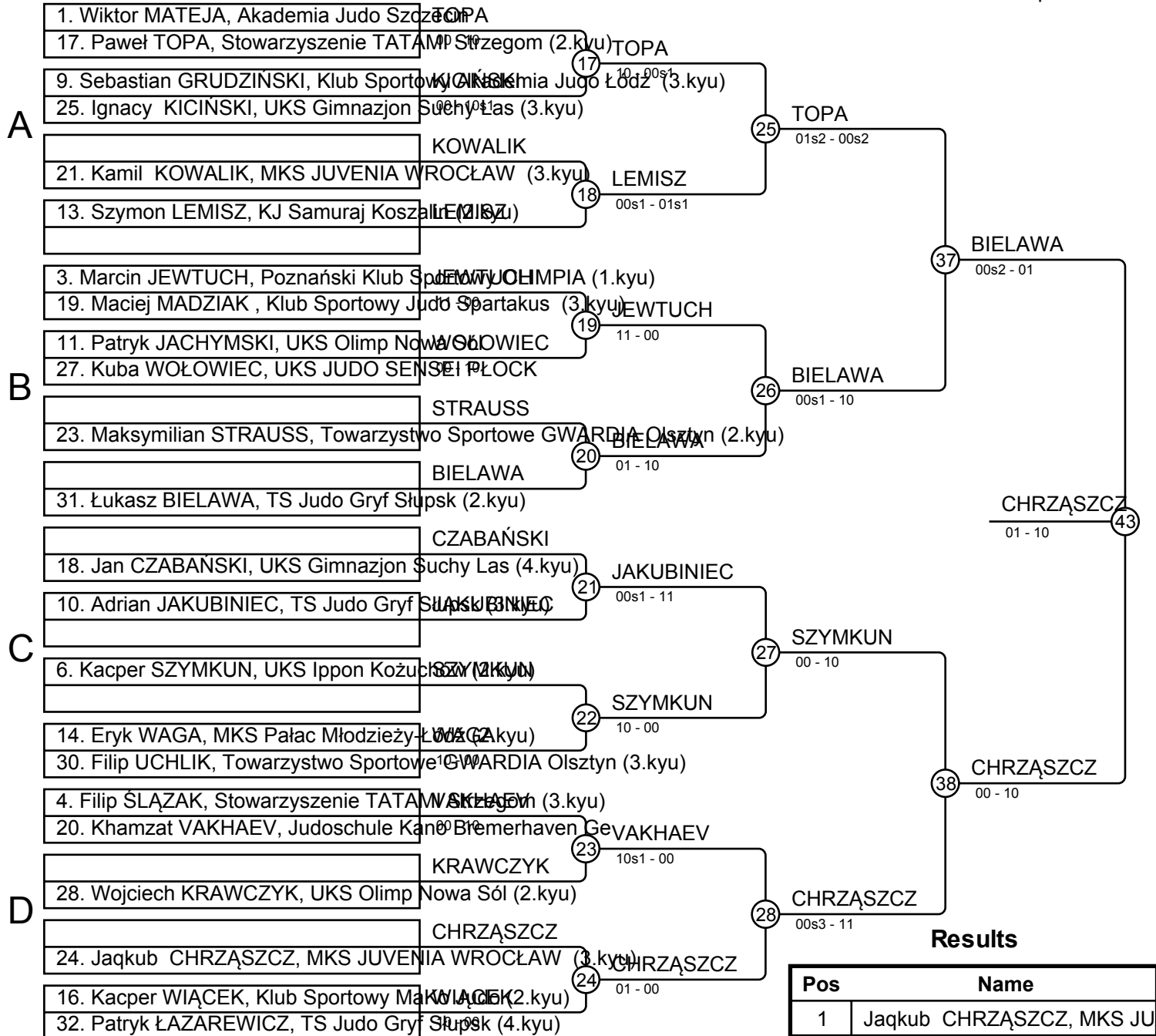

WMTJ 20.03.2022 Suchy Las M U18 -73

Competitors: 16

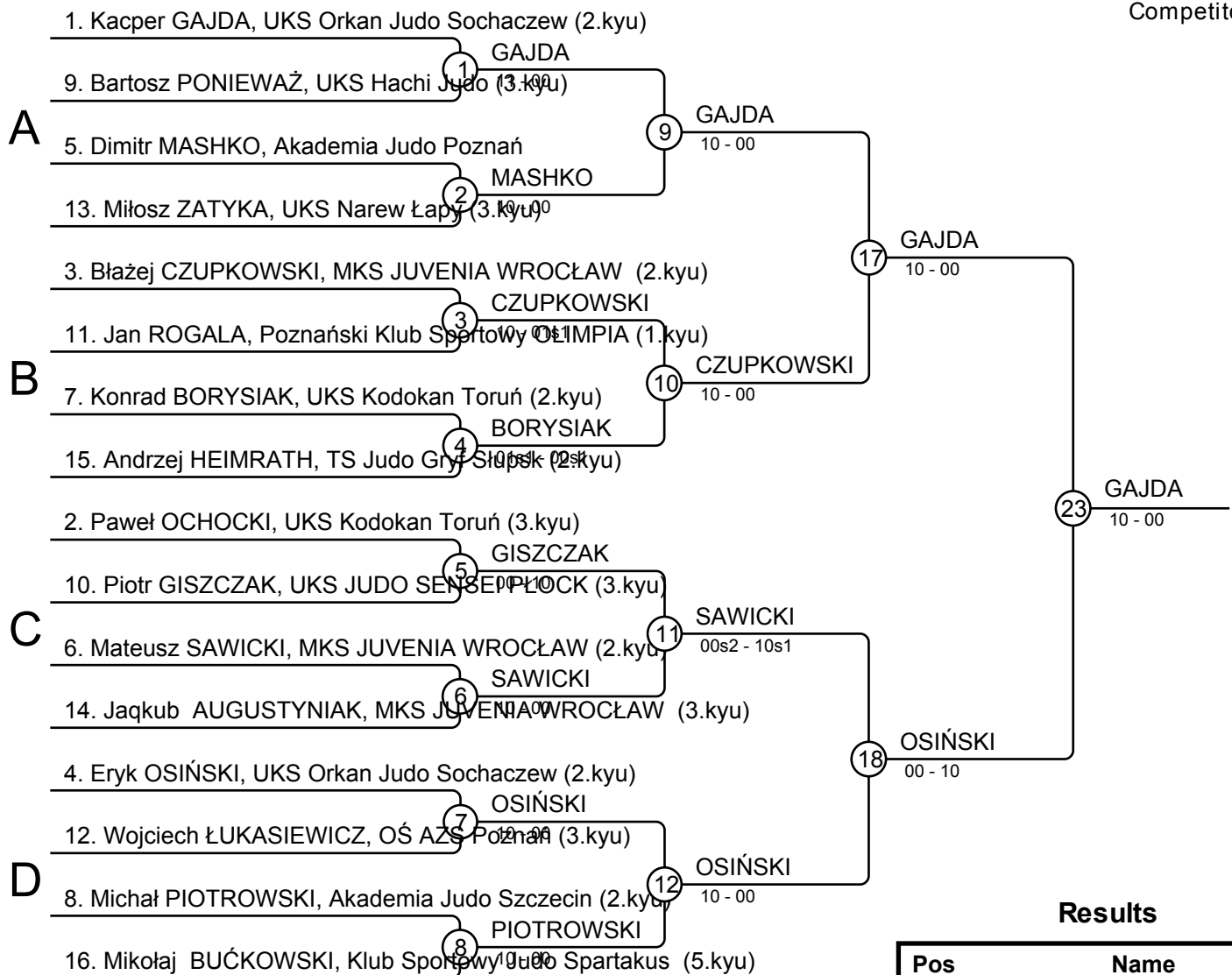

Results

Pos	Name
1	Kacper GAJDA, UKS Orkan Judo Sochaczew (2.kyu)
2	Eryk OSIŃSKI, UKS Orkan Judo Sochaczew (2.kyu)
3	Mateusz SAWICKI, MKS JUVENIA WROCLAW (2.kyu)
3	Piotr GISZCZAK, UKS JUDO SENSEI PŁOCK (3.kyu)
5	Konrad BORYSIAK, UKS Kodokan Toruń (2.kyu)
5	Błażej CZUPKOWSKI, MKS JUVENIA WROCLAW (2.kyu)
7	Dimitr MASHKO, Akademia Judo Poznań
7	Michał PIOTROWSKI, Akademia Judo Szczecin (2.kyu)

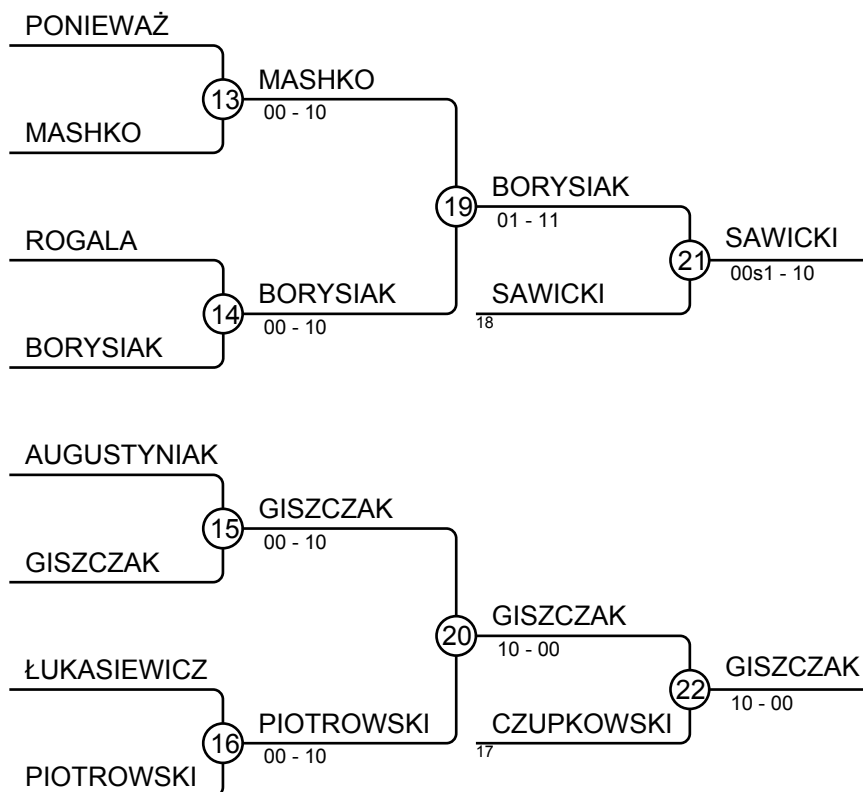

WMTJ 20.03.2022 Suchy Las M U18 -81 kg

Competitors: 10

1. Adam CHOROMAŃSKI, Towarzystwo Sportowe GWARDIA Olsztyn (3.kyu)

A

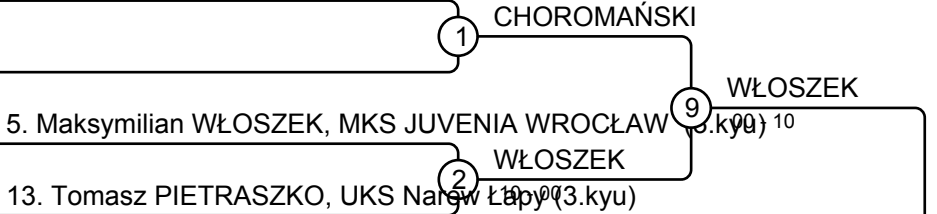

B

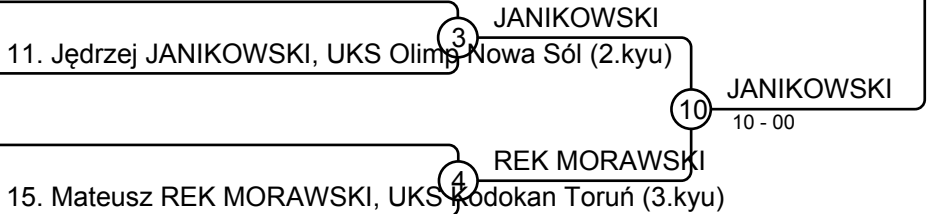

C

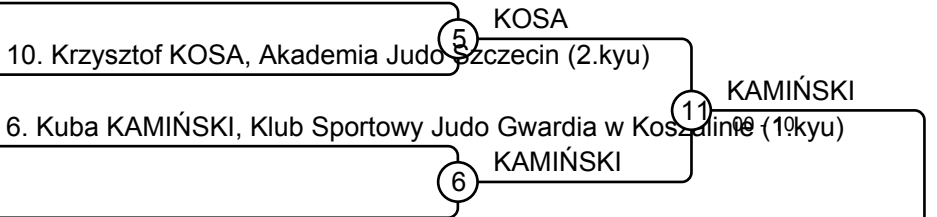

D

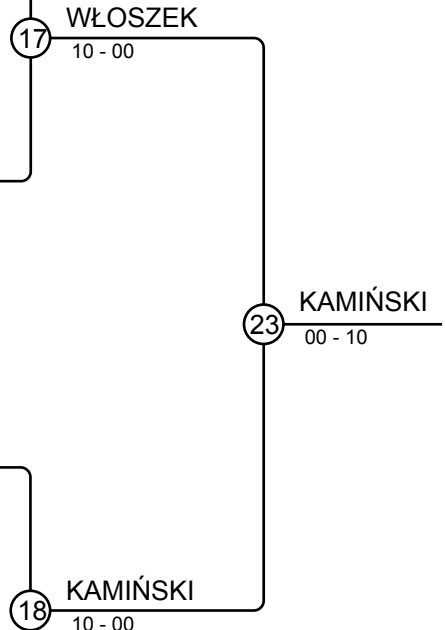
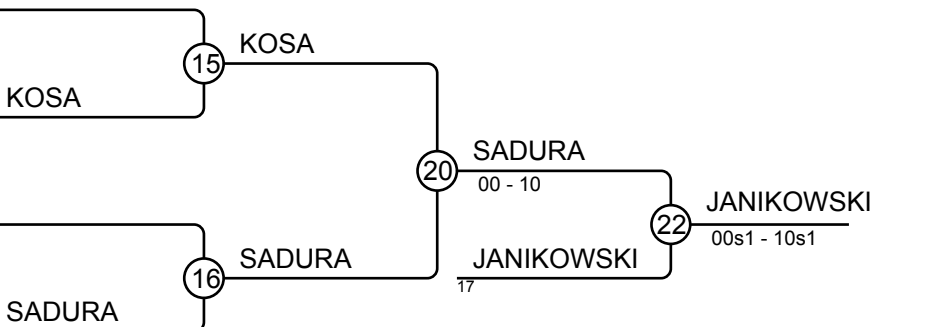
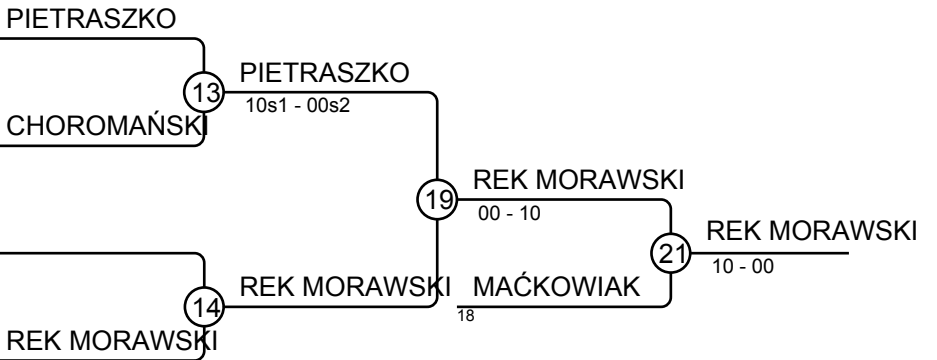
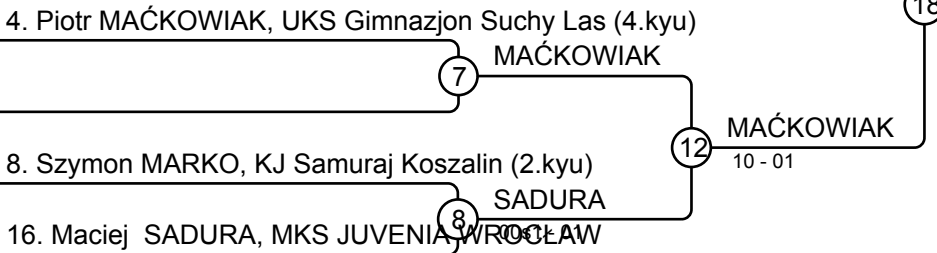

Results

Pos	Name
1	Kuba KAMIŃSKI, Klub Sportowy Judo Gwardia w Koszalinie
2	Maksymilian WŁOSZEK, MKS JUVENIA WROCLAW
3	Mateusz REK MORAWSKI, UKS Kodokan Toruń
3	Jędrzej JANIKOWSKI, UKS Olimpia Nowa Sól
5	Piotr MAĆKOWIAK, UKS Gimnazjon Suchy Las
5	Maciej SADURA, MKS JUVENIA WROCLAW
7	Tomasz PIETRASZKO, UKS Narew Łapy
7	Krzysztof KOSA, Akademia Judo Szczecin

WMTJ 20.03.2022 Suchy Las M U18 -90 kg

Competitors A

Competitors: 6

#	Name	Grade	Club	1	2	3	Wins	Pts	Pos
1	Bartłomiej BARTECKI	3.kyu	Towarzystwo Sportowe GWARDIA Oszyn				0	0	3
2	Mateusz TESMAR	2.kyu	UKS SIMBA	10		10	2	20	1
3	Maciej AUGUSTYN	3.kyu	UKS JUDO SENSEI PŁOCK				1	10	2

Matches A

Match	White	Blue	Result	Time
1	Bartłomiej BARTECKI 1 2	Mateusz TESMAR	00-10	0:13
3	Bartłomiej BARTECKI 1 3	Maciej AUGUSTYN	00-10	3:44
5	Mateusz TESMAR 2 3	Maciej AUGUSTYN	10-00	0:14

Competitors B

#	Name	Grade	Club	4	5	6	Wins	Pts	Pos
4	BRUNO JÓZEFIAK	3.kyu	TKS JUDO TORUŃ				0	0	3
5	Kot MACIEJ	3.kyu	MKS JUVENIA WROCŁAW				1	10	2
6	Wiktor NERS	2.kyu	UKS JUDO SENSEI STARE PROBOŚCZEWICE				1	10	1

Matches B

Match	White	Blue	Result	Time
2	BRUNO JÓZEFIAK 4 5	Kot MACIEJ	00-10	0:31
4	BRUNO JÓZEFIAK 4 6	Wiktor NERS	00s1-11s1	1:51
6	Kot MACIEJ 5 6	Wiktor NERS	00-10s2	4:26

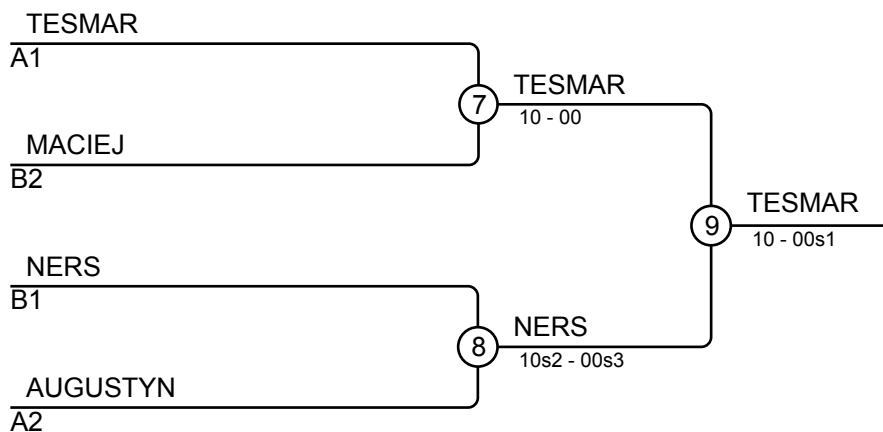

Results

Pos	Name
1	Mateusz TESMAR, UKS SIMBA
2	Wiktor NERS, UKS JUDO SENSEI STARE PROBOŚCZEWICE
3	Kot MACIEJ, MKS JUVENIA WROCŁAW
3	Maciej AUGUSTYN, UKS JUDO SENSEI PŁOCK

WMTJ 20.03.2022 Suchy Las M U18 p90 kg

Competitors

Competitors: 4

#	Name	Grade	Club	1	2	3	4	Wins	Pts	Pos
1	Adrian ŹAK	3.kyu	UKS Kodokan Toruń					0	0	4
2	Hubert ŹUK	2.kyu	TS Judo Gryf Słupsk	10				1	10	3
3	Marcel DOBRIAN	2.kyu	MKS Olimpijczyk Włocławek	10	10			2	20	2
4	Jakub ROSZAK	2.kyu	UKS Ippon Kożuchów	10	10	10		3	30	1

Matches

Match	White		Blue	Result	Time	
1	Adrian ŹAK	1	2	Hubert ŹUK	01s1-10s1	2:31
2	Marcel DOBRIAN	3	4	Jakub ROSZAK	00s1-11s2	3:40
3	Adrian ŹAK	1	3	Marcel DOBRIAN	00-10	0:23
4	Hubert ŹUK	2	4	Jakub ROSZAK	00s1-11	1:04
5	Adrian ŹAK	1	4	Jakub ROSZAK	00s1-11	0:56
6	Hubert ŹUK	2	3	Marcel DOBRIAN	00-11	0:47

Results

Pos	Name
1	Jakub ROSZAK, UKS Ippon Kożuchów
2	Marcel DOBRIAN, MKS Olimpijczyk Włocławek
3	Hubert ŹUK, TS Judo Gryf Słupsk
4	Adrian ŹAK, UKS Kodokan Toruń